



Clextrusion

Summary

Clextral on the Web
www.clextral-framatome.com

Service & maintenance
«First hand assignment»

Development & Process
Performance quantification of the Evolum HT 53

Realizations
Cotton and paper get together

Technology
Extrusion is the future for fish
Evolum LT 145

In brief

Clextral was chosen by UZBUM, the Uzbekistan paper-maker to supply a printing-writing paper-pulp production plant using cotton linters with a capacity of 20,000 T/year. We are proud of our contribution to the economic development of this young Central Asian republic.

The tenacity and determination of our teams, backed by Clextral's expertise in this innovative technology led to the success of this new line in the paper-making industry.

Naturally, technology had a part but perhaps more important was the Clextral team's dedication to meeting our customers requirements that led to this achievement. In a wide variety of fields like agro-food, plastics chemistry or cellulose pulp, as illustrated in issue 4 of your newsletter, Clextral's diverse experience adds valuable insight in meeting the challenges of our customers.

Didier THEVENET
Project Manager

Number 4
DECEMBER 1999

CLESTRAL
FRAMATOME



Cleextral on the Web

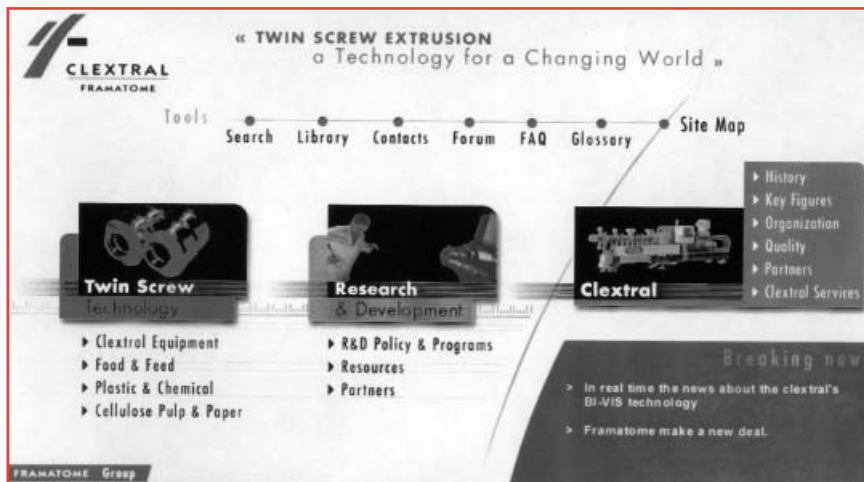

<http://www.cleextral-framatome.com>

The CLEXTRAL Internet site is now accessible to everybody :

Benoit Delaval, Cleextral's marketing manager explains the content of the site to us, and defines the objectives for this new communication tool.

Mariel Badel : ***Why have a Cleextral Internet site?***

Benoît Delaval : *Today, the Internet is a universal communication tool. It means that anybody, anywhere in the world, can obtain information in real time. The twin-screw extrusion technology is used on all 5 continents and Cleextral has equipment operating in 65 different countries. Twin-screw technology users, both current and future, can use our web site to access useful and informative data that is up-to-date and can be obtained quickly and conveniently.*

Mariel Badel : ***What is to be found on the Cleextral site?***

Benoît Delaval : *First and foremost, our site is intended for people seeking information about the twin-screw extrusion technology. Cleextral is the only manufacturer of extrusion systems used in three major application types: agro-food, chemistry/plastics and cellulose pulp. These applications are detailed in terms of processes and finished products. The site also contains a bibliographical section together with a specific glossary of this technology.*

Cleextral's international scale is also evident from our site. Maps make it possible to quickly identify Cleextral locations. Hyper-links allow communication with our representatives and agents via E-mail.

Mariel Badel : ***Do you have a "news" feature on your site?***

Benoît Delaval : *Yes, each month, we publish a "flash" about Cleextral current affairs, accessible directly from the home page. This flash will focus on the latest technology and technical breakthroughs made at Cleextral, enabling our customers and partners to be kept constantly informed of the latest innovations, on a real time basis.*

Mariel Badel : ***Thank you and happy surfing***



Service & Maintenance

Clextral Services : «first-hand assignment...»

How can we ensure a quick and efficient response for our customers operating Clextral extruders on the other side of the world in the Asia-Pacific area? Clextral's solution was to strengthen its commercial presence with a technical team on the spot, now in place for two years in Singapore.

Frustrated by world time zones that limited telephone contact with Asia-Pacific customers to a few hours per day, Clextral technical expert Emmanuel Perroton chose to move to Singapore in order to supply to his contacts in Asia and the Pacific the same level of efficient service offered by Clextral in Europe and in America.

Emmanuel Perroton took with him a solid technical background acquired over ten years, six of them with Clextral Inc., working for North and South American customers.

For more than a year, this experience was enhanced by work with the Clextral process team at Firminy, enabling him to excel in his new service assignments: the start-up of new installations (there will be quite a few of them this year, including a snack line), as well as technical assistance, maintenance visits, machine check-ups, process assistance and user training on extrusion processes.

Based in Singapore, he will be able to provide our hundred or so customers in **Australia, New Zealand, China, Taiwan, Korea, India, Japan, Malaysia, Indonesia, the Philippines, Thailand** and **Vietnam** with immediate and high-quality action, in cooperation with the network of Clextral agents installed in these countries.



D

Development & Process

Performance

Extrusion is a particularly important operation in the transformation of plastics. Using a raw material, it is used for continuous production of compounds or finished products with precise specifications in terms of properties for a specific application.

Today, the market demand is swinging towards machines capable of producing high rates while preserving or even improving the characteristics of the extruded products. In working to achieve these goals, Clextral developed the EVOLUM HT 53 (53 mm screw diameter) whose design and ease of use have already been discussed. However, the essential innovation of this product is its unequalled technological potential in terms of the rotation speed and the available torque, and the optimized temperature control system.

These innovations have been the subject of a series of process tests to validate the characteristics of this extruder and measure its performance in straightforward terms.

Equipment

EVOLUM HT 53:

screw diameter: 53 mm

barrel length: 24 L/D

The machine can operate with continuous pressure under load of up to 275 bars.

Its control system is simple and offers immediate response.

Method

EVOLUM HT 53's achievements in terms of pure performance were first tested on polypropylene, often used as a compound base.

To run these tests, we set independent variables: flow-rate, screw speed, barrel temperature.

We compiled the process responses: power, torque, pressure, residence time, specific mechanical energy (SME) and product responses: fluidity index (MFI: 230°C, 2.16 kg).

Results and discussions

1st test: Behavior of EVOLUM HT 53 when the flow-rate is increased at constant screw speed. Behavior is conventional for the process response.

- The pressure increases in an almost linear manner.
- The torque increases and is proportional to the flow-rate/speed ratio.
- The residence time decreases. The material speed within the extruder increases with the flow-rate.
- The specific mechanical energy decreases and follows the variation of the residence time.

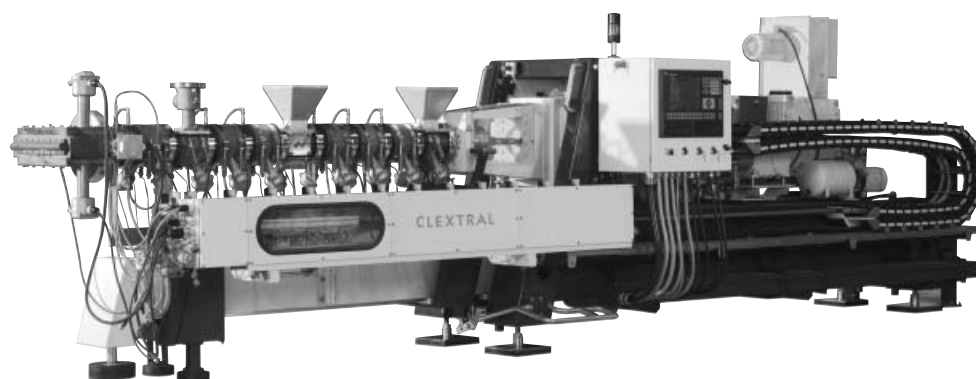

EVOLUM HT 53

quantification of the Evolum HT 53 extruder

2nd test: Behavior of EVOLUM HT 53 when the speed is increased at a constant flow-rate. It was determined that the process and product responses follow known trends.

- The material temperature increases with the increased shear factor.
- The torque and pressure decrease.
- The residence time decreases slightly.
- The specific mechanical energy increases almost linearly (experiment confirmed in parallel by the LUDOVIC 2.0 twin-screw extrusion simulation software).

3rd test: “maximum flow-rate test”. In this approach, Cletral relied on insights in advanced rheology and extrusion gained from thesis collaboration with universities and research centers. To obtain optimum flow-rate while maintaining the product MFI within specifications, an extrusion law was applied, consisting in simultaneously increasing the speed of the screws and the torque.

For instance, we achieve 700 kg/h for a PP filled to 40% with talcum powder.

Technical-economic analysis

We have defined **2 indexes** for comparing EVOLUM HT 53 with a BC45 extruder (diameter 55.5 mm) from the Cletral BC range.

The productivity index: corresponding to ratio: volumetric flow-rate/free volume. This represents the capacity of the extruder. The second index is the **specific standardized**

cost of investment, i.e. the price referred to the production capacity and standardized with respect to the BC45 machine.

Calculations reveal that the operating range defined by the couple capacity/screw speed of EVOLUM HT 53 is far greater, demonstrating the considerable technical potential of this machine. Tests performed for other product types confirmed these results in industrial applications.

Indeed, increasing the available torque and screw speed increase this productivity by a factor of 2 to 5 when compared to machines of equivalent size (e.g. Cletral BC45).

EVOLUM HT 53 also offers an improvement in terms of operational flexibility: due to its high technical potential, this machine is able to achieve more rapidly the equilibrium after start-up and change of extrusion parameters.

In the final analysis, we can state that the Evolum offers a dual advantage in the field of compounding: its functional features considerably boost productivity, and its technical strengths offer important economic benefits.

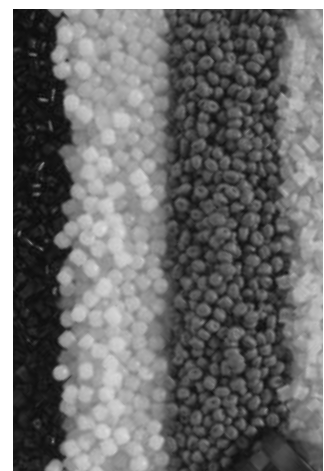
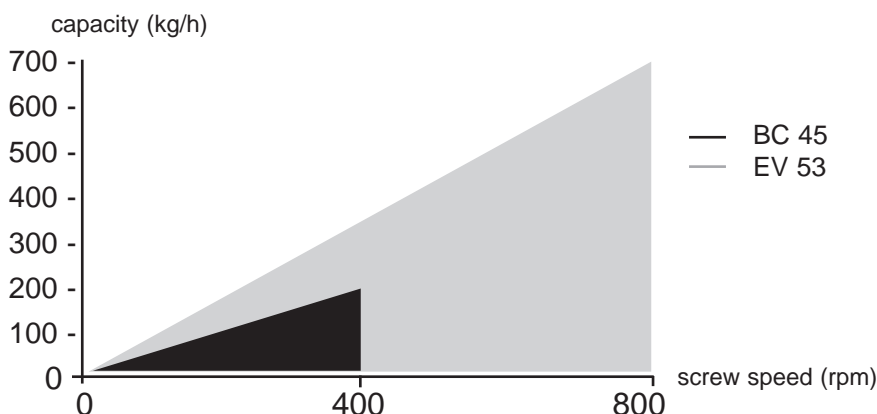

R Realizations

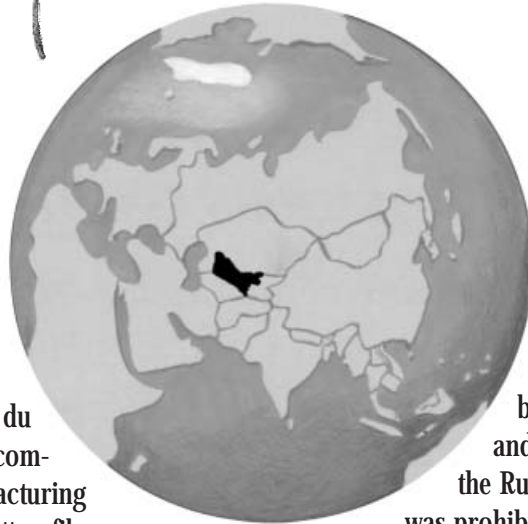

«cotton

Transforming to improve:

Just ten years ago, with La Banque de France and Le Centre Technique du Papier, Clextal developed a highly competitive patented process for manufacturing of fiduciary paper pulp based on cotton fiber. Since 1990, French bank notes have been manufactured using this process, which is noted for its economic use of water, on equipment supplied by Clextal.

A derived process also makes it possible to manufacture printing-writing paper pulp from cotton waste. This is the process used at the Kadoma paperworks in Zimbabwe and the works at Tianjin in China, with installations supplied respectively by Clextal in 1991 and 1994.

As Uzbekistan is the 3rd largest world producer of cotton (after China and the USA), Clextal's contribution to this country's economic development may well have historical significance.



On the silk route:

Uzbekistan is one of the least known countries in Central Asia, at a strategic intersection between East and West, through which the legendary "silk route" runs. It is not well known and for good reason... Uzbekistan's history is inseparable from its two most famous cities: Samarkand and Boukhara. Few places in the world have spurred dreams as much as these caravan cities in Central Asia, with their decisive influence on the world's history for more than 2000

years. But these cities were prohibited to non-Muslims beginning in the 18th century and remained inaccessible during the Russian dominion. Central Asia was prohibited to foreigners. Only when Mikhail GORBACHEV came into power was this area opened to outsiders.

Uzbekistan is one of the first states of the former USSR to have claimed its independence. The Republic of Uzbekistan was founded on August 31, 1991.





and paper get together»...

Since then, the country has moved away from its single role of a "cotton supplier" province and has diversified its economic breadth. Establishing a paper-making industry was part of the goal.

Clextral has been chosen to produce the paper-pulp manufacturing unit of the only paper mill in Uzbekistan, Uzbum, located at Yanguyul (30 km from the capital Tashkent). The ambitious goal is to manufacture 20,000 tons of paper pulp per year while making use of local cotton waste. This investment will reduce paper pulp imports and facilitate the local production of printing-writing quality paper (for 10,000 T). It will also generate currency through the export of part of its production to neighboring countries (for the remaining 10,000 T).

The innovation of the process and the new design of some of the equipment will offer the extraordinary flexibility needed for this installation, offering two distinct production lines.

A turnkey service:

The work load is significant as it is the largest contract achieved thus far by Clextral. The project total value is considerable because Clextral will be furnishing complete equipment and there will be no localizing of manufacturing imposed by the customer, as in some previous projects. It will include the supply of production equipment (including two Clextral KRO 200 twin-screw units), technical documentation, spare parts and supervision of assembly and commissioning, testing and personnel training.

The plant is scheduled for delivery in the summer of 2000 with commissioning 8 months after the beginning of assembly, during the early months of the year 2001, 9 years after the initial contact with the Uzbeks in 1992. The contract was signed in 1997 and entered into force on August 1, 1999.

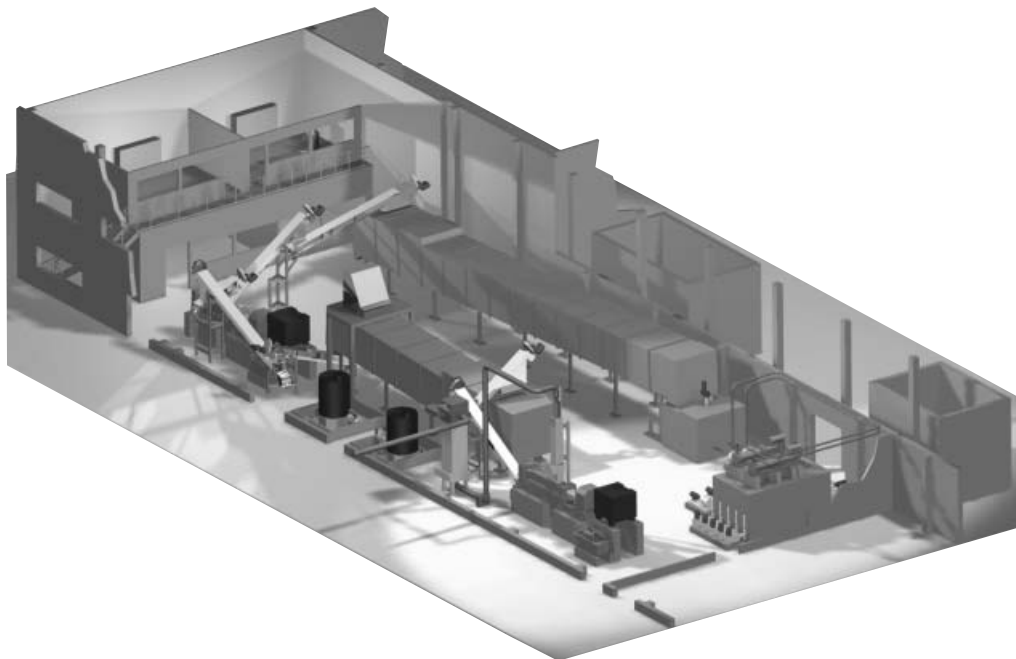

T echnology



Extrusion

Aquaculture, a strongly expanding farming method: As commercial marine fishing becomes increasingly regulated and fish populations decrease, fish farming is becoming an interesting alternative. For the producing countries, it is a way of achieving independence in terms of fish protein and of generating currency (for instance, France has a deficit of FF. 10 billion in fish-farming products).



Over the last decade, fish farming has grown rapidly, averaging 12% per annum.

performance, illnesses, high mortality rates and, in some cases, complete loss of the stock. However, by choosing the right feed, some of these problems can be reduced or eliminated. The quality of the fish feed is particularly critical for the development of the fish farm.

For feed producers, the challenge is to supply the best quality at the best price. This requires technologies and processes combined with knowledge of the behavior of each species.



This trend will continue according to a report by the International Food Policy Research Institute which concludes that within 50 years, fish farming will produce most of the fish we eat.

There are 2 fundamental constraints involved in fish farming:

- Fish feed: this represents between 60 and 70% of the costs of running a fish farm.
- The quality of the water: fish farmers all over the world have had to deal with serious problems of pollution and the resulting effects on water quality: lower

Allowing for tastes and colors:

But let's get back to our fish... Each fish species requires a different type of feed because their eating habits are widely varied. Salmon are somewhat lazy and tend to eat as the food slips slowly in front of their eyes. Trout are more dynamic and will tend to look for their food at the surface. Turbot, on the other hand, will eat from the bed.

The feed intended for alevins whose digestive system is not yet fully developed must be of a shape and size enabling it to be easily caught then digested.

is the future for fish



The processes for manufacturing feed must comply with these constraints: pouring speed, texture and nutritional value must be tailored exactly to each fish consumer (salmon and sea trout, for instance, will need food including nearly 35% fat).

Tailoring each feed to obtain specific characteristics during manufacture benefits the farmer as it can reduce the amount of uneaten food and the resulting “pond pollution”.

A clearly understood protein ratio, well tolerated by the fish, will lead to good digestibility of the food and limit the amount of rejections.

A perfect texture maintains the shape of the food, preventing it from breaking down in the water.

This addresses problems of how the proper specification of food can improve water quality.

The second advantage is economical: farming productivity is improved, the conversion rate is high and farmers can expect that a kilo of food will produce a kilo of fish!

Twin-screw extrusion has proven by its success that this technology is best suited for producing this type of feed.

In fact, extruded feed for aquatic animals has grown in a range of between 8 and 14% over the last few years.

Cleextral’s twin-screw extruders are the fundamental players in this activity and represent 500,000 T/year, one third of the world’s production of feed for fish and shrimp. Using Cleextral twin-screw machines, a highly nutritive food can be produced, with good balance in terms of protein, oils and carbohydrates for optimum assimilation by the animal. By satisfying these criteria, we can create feeds with the highest conversion factors, apt to satisfy any fish species, any feed producer and any fish farmer.

Our machines are designed to be particularly versatile with capacities ranging from 100 to 20,000 kg/h, offering significant advantages:

The high flow-rates ensure improved productivity and therefore a minimum cost per ton of feed produced. The twin-screw extrusion technique reduces matter breakdown and decomposition by 75%.



T echnology



continuation...

«Proprietary» recipes:



Upstream of the extruder, a preconditioner is used to hydrate the ingredients: fish, wheat and soy flours, fat, vitamins and minerals. Using steam and water, the ingredients are heated and humidified then dispersed consistently.

Once the product is introduced to the extruder, complementary ingredients including liquids, steam

The flexibility built into Clextral extruders enables the user to change parameters, for efficient changing from one recipe to another, and for producing feed ranging from 0.5 mm to 30 mm in diameter. Likewise, product density, which determines its sinking characteristics, is easily manipulated. Additionally, the extrusion process cooks the feed ingredients at high temperatures, eliminating any risk of bacteria which could be detrimental to the

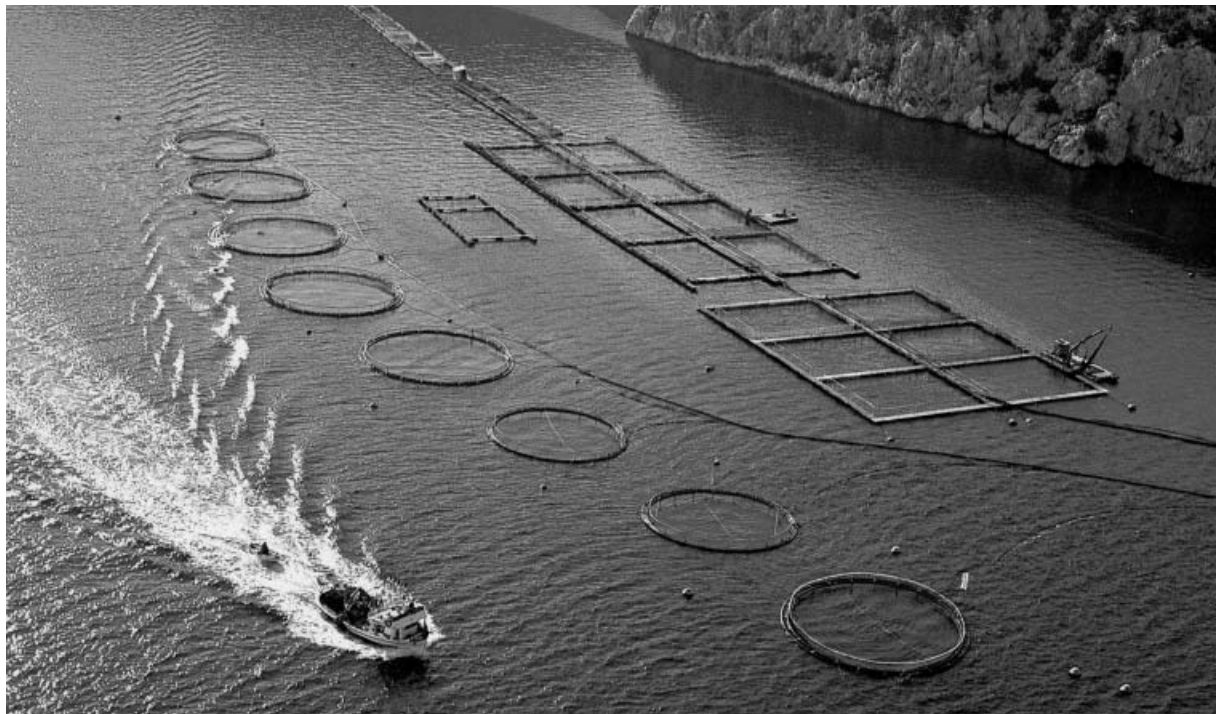

and fish hydrolyates may be added to create products with high fat content and excellent nutritional quality. To achieve fat content around 40%, a final coating may be applied after the product exits the extruder.

As Clextral extruders allow independent and precise testing of each extrusion parameter including temperature, pressure, humidity and residence time, optimum gelatinization is obtained, creating products with maximum digestibility.

health of the animals. The extruded feed is very stable in water, which benefits the environment. The global production of feed for fish farming of salmon, trout, turbot, bass, sea bream and yellow tail is estimated at 6.6 MT for the year 2000. New species currently slated for domestication, including halibut, sturgeon, sole grouper and shellfish will certainly thrive on custom feed processed on Clextral extruders.



A tailor-made menu:

Clextral has developed a new co-rotating twin-screw extruder: EVOLUM LT 145.

This model is designed specifically for production of high quality food in the highly competitive price category of animal feed: fish, of course, but also dogs, cats and other pets.

The modular design of EVOLUM extruders provides the optimum specification for each application.

With EVOLUM LT 145, the production torque is tailored to each application, making the extruder capable of achieving high rates while producing high-quality products. Startup and shutdown phases are implemented very quickly while maintenance and cleaning are easily facilitated. These advantages are combined with a construction method that is renowned for its extreme ruggedness.

The new design of the heat control system also offers many advantages including better density control (with direct effects on floating and sinking properties for fish food), for a wide range of product sizes and formulations. The operator control

screen is mounted on one side of the extruder frame giving a practical overall view.

EVOLUM LT 145 is available in different versions including different motor sizes, screw speeds, sleeve lengths... to obtain flow-rates ranging from 5 to more than 10 tons/hour.

Main technical data:

Screw diameter: 145 mm

Center distance: 119 mm

Maximum torque per shaft: 5267 Nm

Maximum pressure: 125 bar

Maximum sleeve length: 48 D

Maximum motor power at maximum screw speed

- 221 kW at 200 rpm

- 441 kW at 400 rpm

- 662 kW at 600 rpm

- 882 kW at 800 rpm

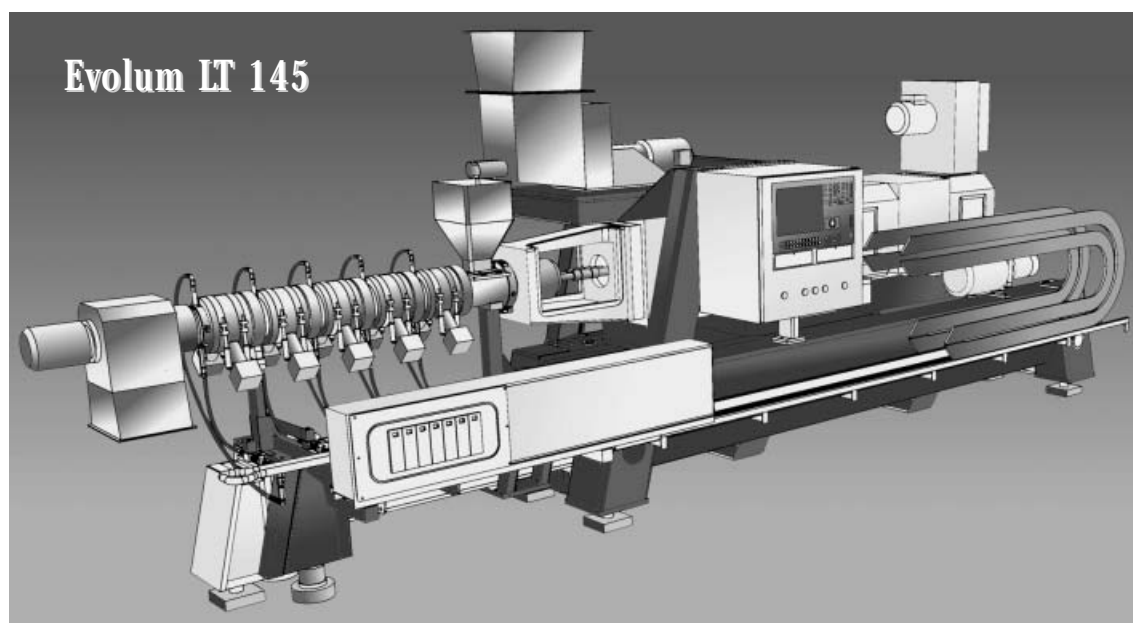

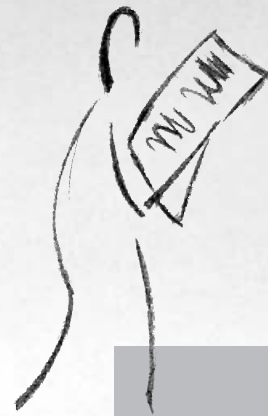

In brief...

Jean-Marie BOUVIER is taking over responsibility for the twin-screw extrusion activity at Clextral.

He is seconded by Patrice Breillot, sales Manager; Laurent Bruyas, Technical Manager, heading up R&D and process, the test station and engineering; Didier Thévenet, project manager; Serge Maisonnay in charge of manufacturing and Georges Hallary supervising Clextral services and twin-screw purchasing.

Clextral, the twin-screw technology leader is widening its supply to other products placed upstream and downstream of the twin-screw offerings. This is the case for the forming equipment produced by **Afrem International** with which Clextral has developed a worldwide sales partnership thanks to its network of agents and subsidiaries.

New e-mail address Emmanuel Allibe (Clextral Asia-Pacific) :
e.allibe@pacific.net.sg



CLEXTRAL Inc
14450 Carlson Circle
Tampa, FL 33626 USA
Tel. 1 813 8544434
Fax. 1 813 8552269
E.mail: clextralUS@aol.com

CLEXTRAL S.A. B.P 10
42702 Firminy cedex
FRANCE
Tel. 33 4 77 40 31 31
Fax. 33 4 77 40 31 23
E.mail: clextraldc@aol.com

CLEXTRAL A.P.
4th floor, 74 C Duxton road
SINGAPOUR 089533
Tel. 65 225 27 26
Fax. 65 225 29 39
E.mail: e.allibe@pacific.net.sg