



Clextrusion

Summary

Exclusive
New Clextral Group :
defining innovation

Services
& Maintenance
Teleassistance

Development
& Process
Flat bread is as trendy
as ever

Clextral Inc.
The first proteine fibrillation
workshop

Clextral Services
Service engineers :
trained & trainers

In brief...

www.clextrusion.com
www.clextralgroup.com
www.clextral.com

CLEXTRAL

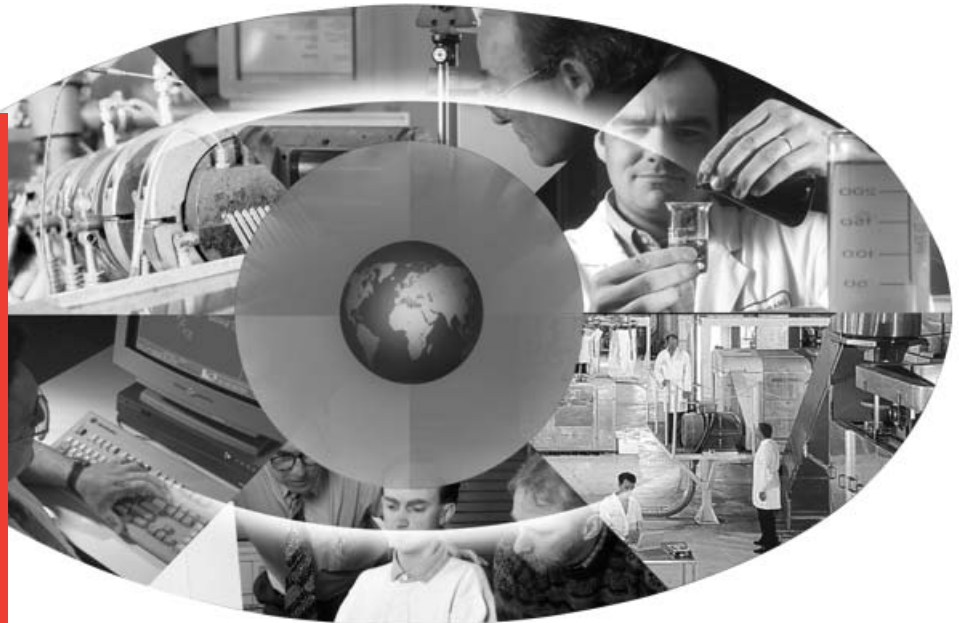

In 2002, CLEXTRAL teams successfully completed installations on all 5 continents, providing equipment and services for manufacturers of food, chemicals and plastics, and paper pulp. These production lines include growing numbers of new generation TWIN-SCREW EVOLUM machines. Furthermore, they have been built to meet specific customer requests, and integrate new services.

Moving beyond TWIN-SCREW extrusion lines, the CLEXTRAL range has been expanded! With the acquisition of the AFREM and LYMAC companies, the new CLEXTRAL GROUP is now able to provide complete pasta and couscous lines, together with the appropriate packaging systems, on a worldwide basis.

As a part of our commitment to providing worldwide service, we have recently opened an office in SANTIAGO, CHILE, to support CLEXTRAL, AFREM, and LYMAC equipment service and sales. In addition, CLEXTRAL NORTH AMERICA in the USA now offers an EVOLUM 53 in the test plant for customer R & D and trials.

With our growing presence worldwide, and the ability to supply integrated systems and processes, our teams look forward to the coming years with confidence. We are even more determined to adapt our services to your requirements, through improvements in our procedures, and, as always, through our proven ability to innovate.

G.Jobard
President of Management Board.

E xclusive



New Clextral Group : defining innovation...

The new Group, which is the result of links between 3 companies, (CLEXTRAL, LYMAC and AFREM) at the initiative of CLEXTRAL, is solidly established in the Rhône-Alpes region, in France. Its objective is to create tomorrow's processes and products, in cooperation with its customers.

The 3 specialized companies, each a pioneer in its particular field, are all strongly anchored in a highly dynamic culture of technological innovation.

The CLEXTRAL Group designs units of industrial equipment for the food industry and in niche markets with high added value (chemicals, plastics, petrochemicals and special paper making).

It now supplies dosing, mixing, baking, extrusion, drying, and packaging equipment in 80 countries worldwide, with 12,000 units in operation.

Within its manageable size, our group brings together four specialized fields: TWIN-SCREW extrusion, DKM dosing pumps, pasta production lines and packaging systems.

Each company now has local offices close to their clients: in France (R & D centre

and industrial establishments) and also in the USA in Tampa (R&D centre), Santiago in Chile, Singapore, and Shanghai in China.

With the LYMAC company, CLEXTRAL is now able to provide complete packaging systems wherever they are required, downstream from its TWIN-SCREW extrusion lines.

These packaging lines include two highly innovative products: a bagger for dry products, which is particularly robust and easy to use, together with a vertical cartoner that can be used with a wide range of carton formats, providing top flexibility to meet changing market demands.

With the AFREM company, the CLEXTRAL Group has moved into the leading position worldwide in the field of semolina (couscous) lines and has moved to the cutting edge of technology on the pasta market and the associated drying equipment. AFREM possesses well-known expertise in the field of very high temperature drying, with all the resulting advantages in terms of overall space requirements.

The teams of all three companies take pride in the formation of the Group, and in the new products and services that they now offer to their clients.

GEORGES JOBARD
President of Clextral
Management Board



JEAN-MARIE BOUVIER
Clextral Vice President
(extrusion Business Management)



DIDIER THEVENET
DKM Pumps Director



JOËL MAISONNIAL
President of Lymac



MARC RABANY
President of
Afre International



S Service & Maintenance

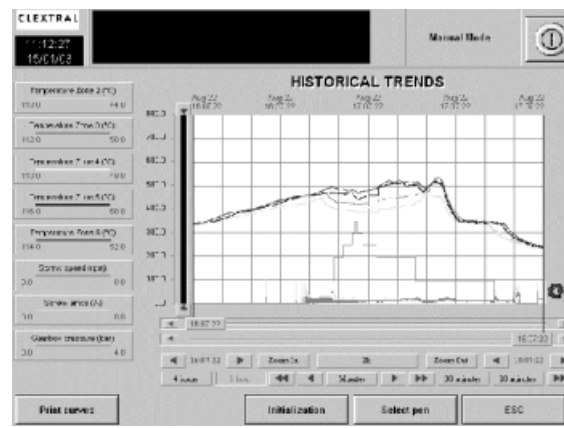

Teleassistance

Remote support :

How does Clextal S.A.S. provide superior technical service and trouble-shooting for machines and production lines operating in 65 countries around the world? Remote support is one way to optimise production equipment simply, efficiently and cost-effectively. This service allows technicians to check operating parameters, monitor operation, troubleshoot and resolve problems using a modem link, providing an immediate response to customers whose plants may be hours away in travel time. Clextal offers this service to all customers whose machines have computerized operating and control systems.

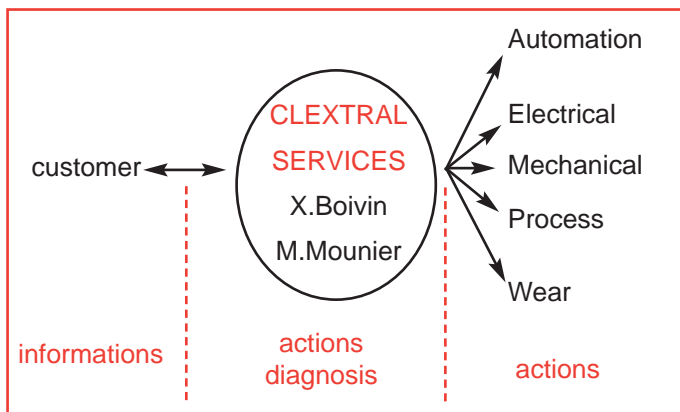

In real time :

Data is sent from a control point, via a modem and a telephone line, to a compatible reception unit. The receiving operator displays the extrusion conditions on his screen in real time: setting values and actual values, curves showing tendencies, past history, alarms and failures, etc. The remote technicians can intervene on the automatic controller to check that its operation, or adjust certain variables following the replacement of sensors or actuators.

The system has many advantages :

- control and standardization of production conditions on sites that are separated by considerable geographical distances
- dialogue with the machine operators to optimize the distant

parameters

- real-time aid in diagnostics in the event of a line malfunction or stoppage
- a process aid service for the development of new products
- the security of fast, specialized assistance in many fields : mechanical, electrical, process, metallurgy, engineering, automation,...

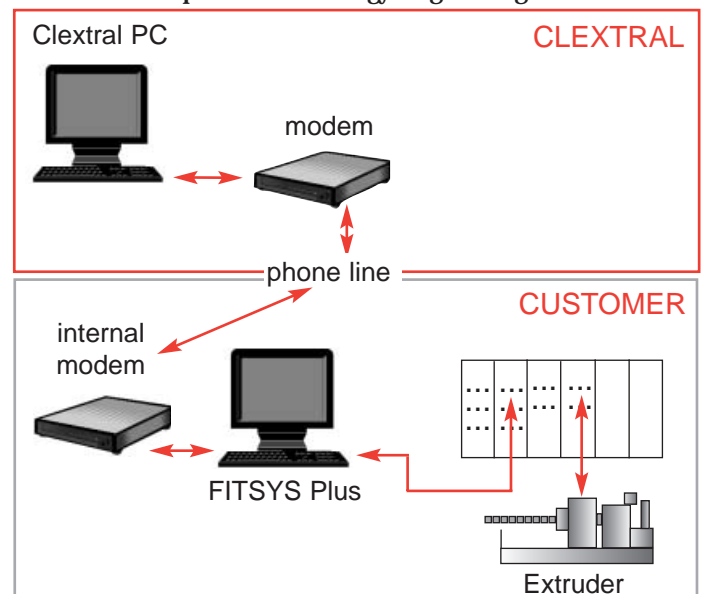

This system of remote support provided by Clextal is applicable to extruders in the EVOLUM range, working with Allen Bradley and Siemens automatic controllers and the INTOUCH supervision system.

Evolving services

In the future, additional services will be available :

- video camera surveillance of the machine, to provide a visual display of the process status
- online access to specific Clextal documentation
- utilization of process elements such as screw composition software, recipes, and modelling.

Moreover, it will be possible to integrate specific programs providing maintenance aid.

A. Brisset et T. Jarousse



D

evelopment & Process

Flat bread is as trendy as ever

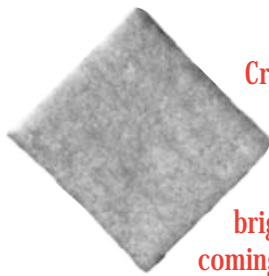

Crispy food products have been tremendously popular with consumers over the last few decades, and the future looks bright for increased interest in the coming years. Often called crispy flat breads, these products were first produced by twin screw extrusion in the early 1970's. (1971 : BSN, CTUC and Clextal).

are you familiar with flat bread ?

Good tasting, nutritious and shelf-stable, crispy flat breads have occupied a consistent position in the highly competitive food marketplace since their debut over 30 years ago. Eaten for breakfast, as a snack or an accompaniment to any meal, these versatile products are enjoyed by consumers around the world. New products, such as filled crispy flat breads, have fulfilled the demand for new twists on these popular foods.

The crispy flat bread generally has a square or rectangular shape with a wide range of possible dimensions. For example, it can vary from the small flat bread (37 x 37 x 6 mm) that is eaten for a snack to the large flat bread (100 x 65 x 7 mm) that is enjoyed



as toast for breakfast. It has a smooth surface appearance due to the regular expansion, and its color is usually a light or golden brown. The flavour is generally neutral and roasted. Its distinctively crispy textu-

re is due to the highly aerated cellular structure.

The raw materials used to manufacture crispy flat bread by extrusion-cooking are starch-rich and cereal-based. Wheat flour is commonly the major ingredient, often blended with rice, corn or other grains. Other ingredients, including sugar, salt, milk powder and oil, are usually added for their specific functional properties.

A simple, evolving process

These ingredients affect the taste, texture and other qualities of the final product. The selection of raw materials and formulation are very important to optimize the characteristics of the final products.

The raw materials are stored in silos. All selected ingredients are transferred via weigh stations to a mixer. The finished mix is then conveyed (via a pneumatic and/or screw conveyor system) into the hopper of the feeder, which feeds the dry mix to the extruder. Piston pumps meter the liquid additives (such as water and oil) into the extruder.

Crispy flat breads are manufactured on an industrial scale using an intermeshing co-rotating twin-screw extruder. The machine is equipped with a variable speed motor and performant reduction gear. The screws are configured by assembling modular parts on 2 splined shafts. A wide range of screw elements is available to optimize the thermomechanical work of the material. The barrel that houses the screws is composed of several modules. Each module is equipped with a heating system, a cooling system and a thermocouple to ensure accurate control of the processing temperature along the machine.

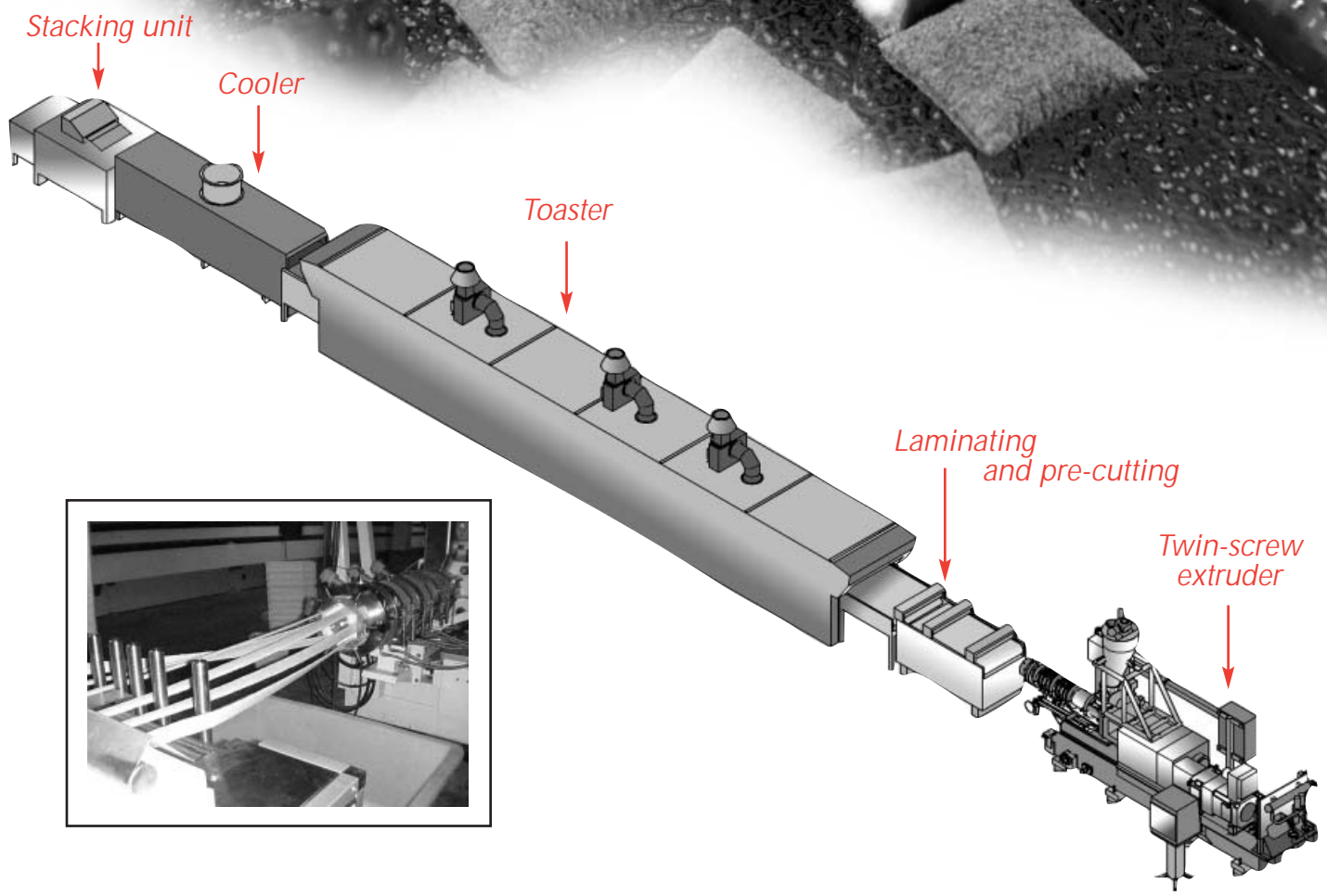
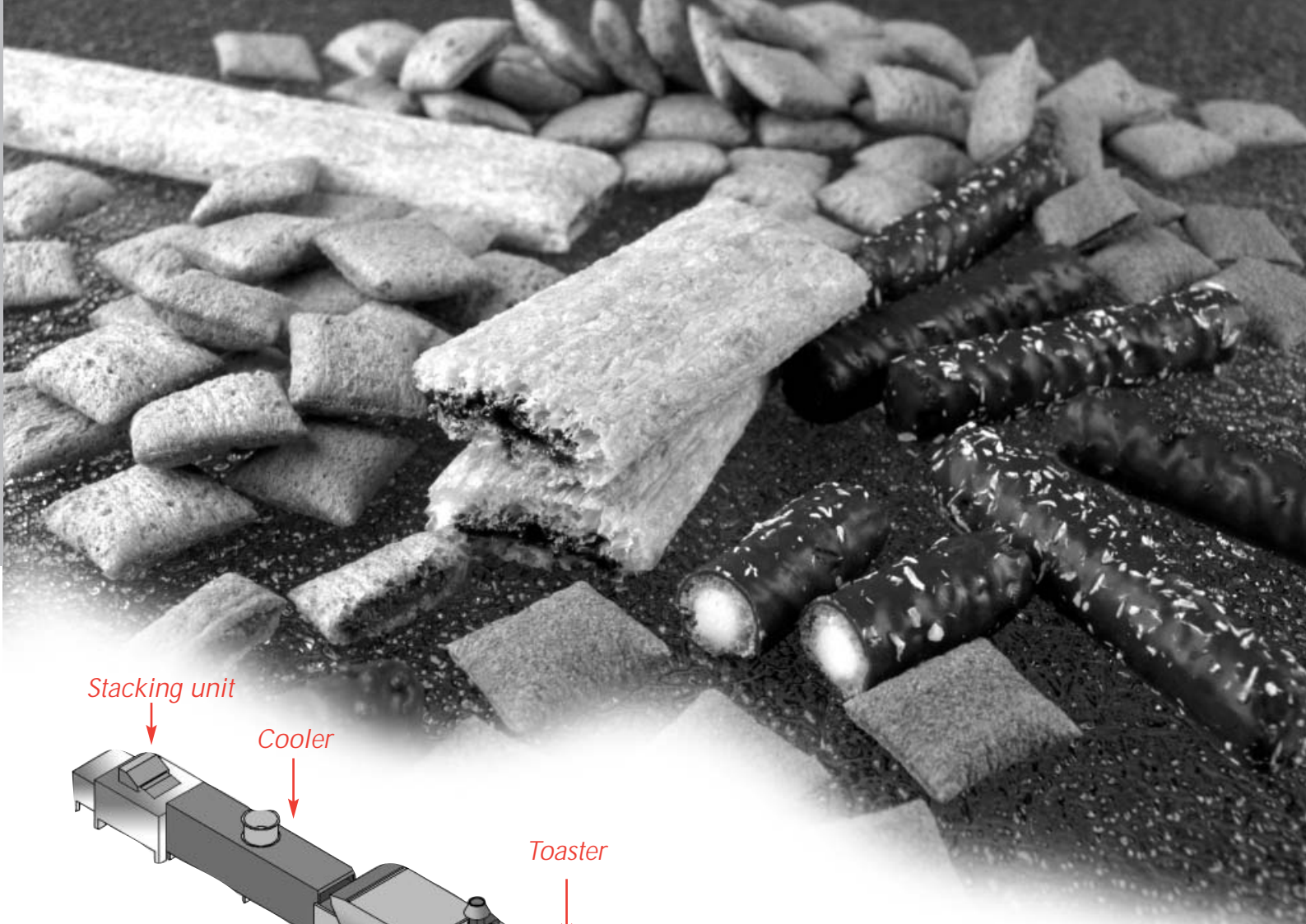

All along the barrel-screw assembly, mechanical and thermal energies are supplied to the product, to cook the starchy materials. As processing is completed, the dough enters the die, which simultaneously textures and forms the product. The texture of the product is obtained as the moisture in the product turns to steam (flashes off) caused by the change in pressure as the product exits the die. Upon exit from the extruder, the mal-

leable bands of product are laminated and pre-cut to create the desired profile of the flat bread product. Next, the bands enter an oven to toast the flat bread : reduce the moisture content and produce the brown color on the surface (Maillard reaction). Then the bands of pre-cut products are cooled and finally cut with a brush system that separates the individual slices, which are subsequently moved into the packaging unit.

D

Development & Process

cont^d...

A combination of crunchiness and softness...

This product, which is a variation of the crispy flat bread, combines two textures : a crispy outer shell surrounding a soft filling.

Generally, these products are the shape of a flat bar (100 x 32 x 12 mm are common dimensions).



The filling provides the predominant flavor to the product, complimented by the roasted taste of the biscuit.

The crispy shell has the same characteristics as crispy flat bread : light brown color, crispy nature, smooth surface appearance, formulation.

The filling is often sweet : chocolate or fruit paste. This filling contains little water content and consists of a matrix that is predominantly fatty and/or sweet.

Here, the choice of the formulation and raw ingredients (for the biscuit and also for the filling) are critical to optimize the characteristics of the product.

The processing line is similar to a crispy flat bread production line. In fact, we can produce the filled product on the same production equipment as crispy flat bread with only some minor adjustments : a special die is used to concurrently form, texture and fill the product. Separate container tanks are used to store the filling before it is pumped to the die.

Flat bread to suit all tastes

Many types of cereals can be produced and a large range of crispy flat products can be made continuously by the extrusion-cooking production line. The simplicity of the equipment, the quick and easy change of formulas and product designs also make this process very productive and flexible.

The capacity of the lines varies between 300 and 1000 kg/h for crispy flat bread slices, and 550 and 1100 kg/h for filled crispy flat bread bars.

Crispy flat breads and filled crispy flat breads are good examples of how extrusion processing allows manufacturers to utilize energy-efficient equipment and inexpensive raw materials to create value-added products that succeed in the world marketplace.

Although the flat bread market is seen as a mature market in Europe, there is growing interest for this type of product in many other parts of the world.

A large number of companies have shared Clextal's expertise to open up new markets, some of them quite recently : in Brazil (production line with a capacity of 450Kg/h), in China (production line with a capacity of 800 Kg/h), or in central Europe (flat bread with various fillings in Ukraine and Russia).

Give your imagination free rein !

Flat bread is a food with a future ! Many lines of research, such as pre- and post-extrusion flavoring, or coating, have not yet been developed. New textures can be obtained by combining the various raw materials and functional ingredients in different ways.

The products known as «Health» foods, which show strong growth potential, also correspond to this market.

The flexibility of the lines proposed by Clextal enables it to meet market requirements rapidly in all cases.

E. Lavocat

Clextral Inc.



The first protein fibrillation workshop : a success !



January 23, 2003 - Clextral Inc. in Tampa was the setting for a noteworthy event as industry specialists gathered for the first protein fibrillation workshop.

After a presentation of this innovative extrusion process and its applications, the attendees were invited to see a demonstration of the protein fibrillation technology run on one of the two extruders in the U.S. pilot plant. A soy-gluten based recipe was processed to create a whole-muscle meat-like product. Afterwards, Clextral presented some finished products made with extruded fibers, including nuggets with breadcrumb coating, vegetarian steak and ground meat.

The visitors appreciated the high quality of the product, along with substantial mouth-feel and good texture and commented on the excellent microbiological properties of the fibers that

workshop

are «sterilized» by the heat and pressure treatment inside the extruder.

The **protein fibrillation technology** is a unique high moisture extrusion cooking process developed by Clextral that transforms vegetable or animal proteins into meat-like whole muscle, adding measurable value to the raw material being processed.

The final applications for these products include vegetarian entrees, prepared food ingredients, and high-end pet-food.

Clextral supplies the technological expertise, R&D, and complete processing lines. Feasibility tests and product development may be conducted at Clextral Inc. (USA) and in the laboratory of Protial, a Clextral partner in France.

G.Maller

Clextral Services

Service engineers : trained & trainers...

The Clextral Services team is on the go to give fast, professional service and comprehensive training on developments in extrusion systems to our clients around the world.

The team includes specialists with skills in the mechanical, electrical, automatic and process fields, with the support of all Clextral departments during its interventions on customers' premises.

Clextral Service technicians put machines into service, provide maintenance, repairs and modifications, and offer staff training which enables our clients to benefit from Clextral's experience and expertise. **X.Boivin**





In brief...

Lymac : expertise in turnkey packaging systems



LYMAC, a new member of The CLEXTRAL Group, provides global solutions for packaging. Lymac machinery packages food products such as extruded cereals, pasta, rice, couscous, etc., and products in the powder and detergent industries.

The innovative LYMAC vertical bagging system is efficient, simple and robust. The LYMAC cartoner is known for its reliability and easy changeover to different formats in just a few minutes. These units, which were recently presented at the packaging show in Paris, may be commercialized on their own, or integrated into a complete packaging line.

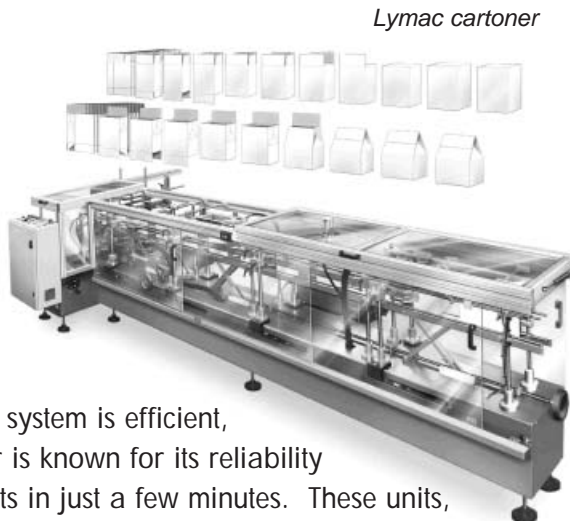

LYMAC : lymac@wanadoo.fr - tel. +33 (0) 478 442 695

Ludovic Lacau, a sales engineer trained in all the technologies of the Clextral Group : extrusion, pumps, packaging, and equipment for pasta and couscous, will soon be based in **Santiago**, Chile, in the office serving Latin America.

After spending 15 years in various positions with Clextral, including 7 years at the head of Clextral Inc., **Benoit DELAVAL** has been appointed **Vice Chairman of Afrem International**.

You can meet the CLEXTRAL Group teams during a number of shows in 2003 :

SNAXPO 16-18 March 2003 - San Francisco - UNITED STATES OF AMERICA
PASTA Moscow 1-4 April 2003 - Moscow - RUSSIA
ANUGA FOODTECH stand 14.1 F 71 8-11 April 2003 - Cologne - GERMANY
PACKTECH FOODTECH 9-11 April 2003 - Shanghai - CHINA
PACEX 6-8 May 2003 - Toronto - CANADA
ACHEMA stand 8 E35-E36 - 19-24 May 2003 - Frankfurt - GERMANY
MEB 21-24 May 2003 - Cairo - EGYPT
IRAN AGROFOOD 25-28 May 2003 - Teheran - IRAN
National Pasta Association 8-10 June 2003 - UNITED STATES OF AMERICA
FISPAL 10-13 June 2003 - Sao Paulo - BRAZIL
SNACKEX stand E1 - 9-10 June 2003 - Barcelona - SPAIN
FOIRE D'ALGER 11-19 June 2002 - Algiers - ALGERIA

CLEXTRAL S.A.S.
B.P 10
42702 Firminy cedex
FRANCE
Tel. 33 4 77 40 31 31
Fax. 33 4 77 40 31 23
E.mail : clxsales@clextral.com

CLEXTRAL Inc.
14450 Carlson Circle
Tampa, FL 33626 USA
Tel. 1 813 8544434
Fax. 1 813 8552269
E.mail : clextralusa@clextralusa.com

CLEXTRAL Asia Pacific
4th floor, 74 C Duxton road
SINGAPORE 089533
Tel. 65 6 225 27 26
Fax. 65 6 225 29 39
E.mail : eallibe@clextral.com

CLEXTRAL Latin America
C/O CFCCI
Marchant Pereira 201, OF.701
PROVIDENCIA
SANTIAGO
CHILE
Tel. 56 2 225 55 47
Fax. 56 2 225 55 45
E.mail : llacau@clextralusa.com
jcoelho@clextralusa.com

CLEXTRAL China
Room 9001
Novel Building
887 Huai Road (M)
SHANGAI 200020
CHINE
E.mail : jchen@uninet.com.cn