

Clextrusion

Summary

Technology

Control of wear...

Development & Process

-3rd. generation snacks

-Texturized vegetable proteins.

Environment

Packing chips.

Realizations

Turnkey recycling.

In brief...

Questionnaire.

www.clextrusion.com
www.clextralgroup.com
www.clextral.com

Since March 1998, we have had the pleasure of keeping you informed about new developments at CLEXTRAL via this newsletter, CLEXTRUSION.

In this issue, N° 10, you can read about CLEXTRAL's progress in 2003. You can also view this issue online at www.clextrusion.com. This issue N° 10 ends a series.

The magazine is evolving, and beginning with the next issue planned for June 2004, we will cover the innovations of the new CLEXTRAL Group, including extrusion, dosing, shaping, drying, packaging, etc., for all the group's customers and prospects, in over 100 countries.

To help us better meet your expectations, please indicate how you would like to receive the new form, as requested on the last page.

I would like to thank you for your trust and the interest you take in our progress, which you will have a hand in shaping, especially as we accompany you during the creation of your products, improvements in your processes, and the widening range of our offer as an integrator and service provider. All our best wishes for 2004 !

Georges Jobard
President of Clextral Management Board

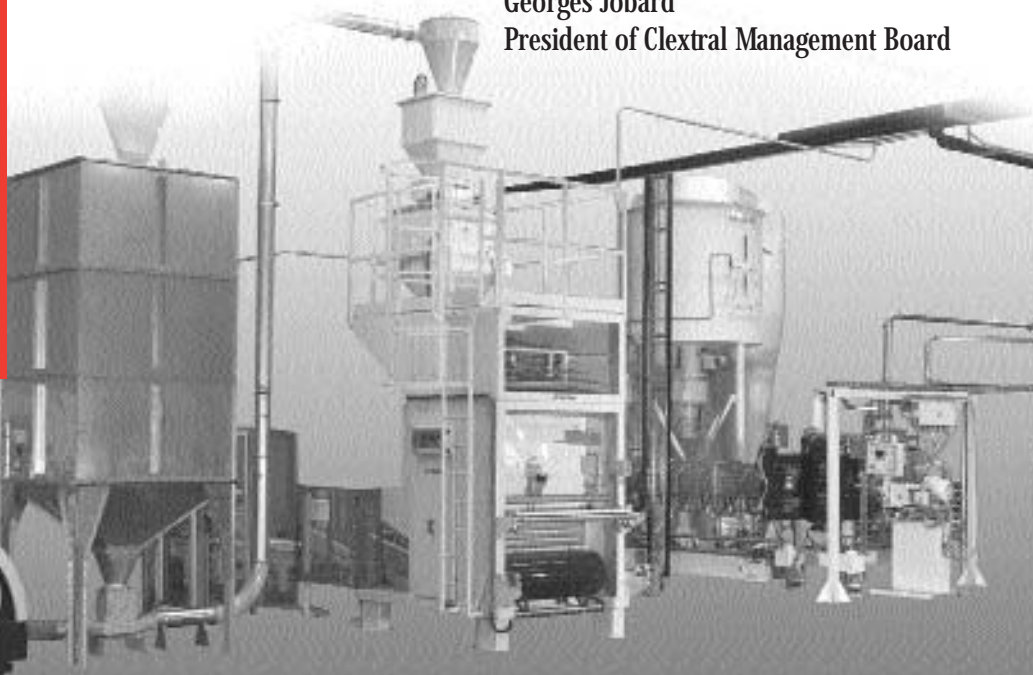

From raw materials to the packaged product

Numéro 10
janvier 2004



CLEXTRAL
Group

T

echnology



Control of wear

As a supplier of complete extrusion lines, Cletral is dedicated to managing wear in its equipment.

Process and cost control (food safety, precise control of the parameters and the reactions, etc.) are powerful motivators for adapting a metallurgical solution to any given process.

This is especially important for the extruder, in which the raw materials are mixed and compressed, and undergo thermomechanical treatment between the screw and the barrel.

It is necessary to understand the mechanical and chemical phenomena in the situation to put forward the best solution.

Reliable methodology enables optimization of the cost of wear per tonne, a key parameter when calculating the return on investment for a production line.

COMPREHENSION :

The initial stage consists of anticipating the various types of deterioration in the extruder.

This task is not a simple one, because each unit function carried out in the equipment (see figure 1) corresponds to a type of deterioration, which varies according to the operating conditions (see figure 2).

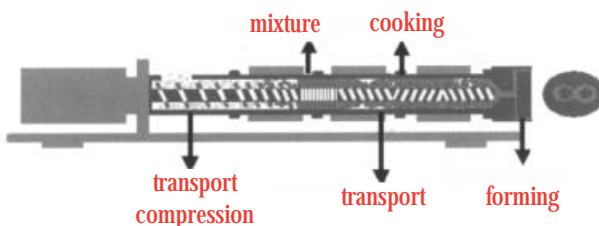

figure 1 : unit functions of the twin screw extruder

Thus, depending on the viscosity of the product for example, a particular area can undergo erosion, abrasion, cavitation, or a combination of different modes of deterioration.



figure 2 : Modes of deterioration in the twin screw extruder

This initial assessment of the deterioration modes and knowledge of the chemical compounds concerned enables us to determine the materials that can be used for the process.

METHODOLOGY :

To provide increased levels of skills in this field, a system was developed to continuously measure the stresses and pressure levels in the extruder.

It is used during tests in our pilot test centre to complete a database that helps to define suitable materials.

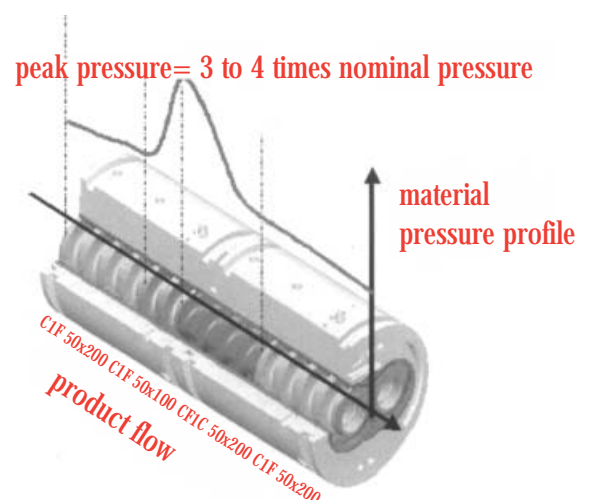



José Cheio de Oliveira

in twin-screw extrusion

However, in certain extreme cases, metallurgy has its limits, or rather the cost of wear for a given process has its economic limits.

Then it is necessary to adapt the process, for example by re-working the screw profile or the temperature, or even by limiting the machine output.

This enables us to avoid operating conditions that are too severe, because in the field of wear, the laws of proportionality do not apply.

In some cases, an increase of 20% in output can lead to a reduction in the service life of the wear

USE OF THE RESULTS :

Once the procedures have been implemented, results may be gained in a few months of operation, allowing the wear costs per tonne to be precisely determined.

This information provides the basis for creating a maintenance schedule and decision table.

This can reduce downtime by allowing the user to anticipate machine stoppages and order replacement parts depending on the wear levels noted (see figure below).

decision table

- Level 1
acceptable wear : no action
- Level 2
check barrels and screws in stock
- Level 3
maximum wear levels reached
replace the parts

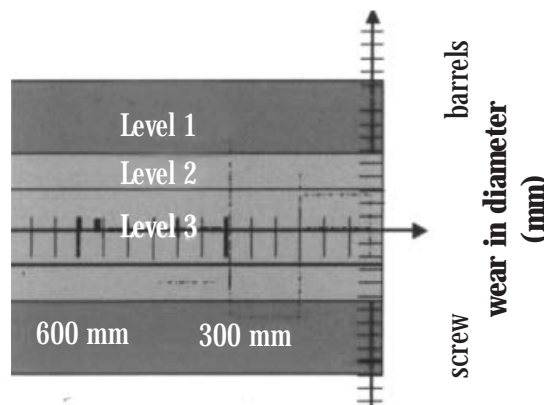

parts that is proportionally much higher.

MEASUREMENTS :

Control of wear involves detailed measurements and this is the costliest phase in terms of resources, as highly precise geometrical monitoring is required for the wear parts and the operating conditions for the machine.

This step often requires the involvement of CLEXTRAL staff to monitor the machine, because of their experience in this area.

It is thus clear that the control of wear is necessary to optimize the productivity and safety of the equipment. It involves a partnership that enables CLEXTRAL customers to benefit from the company's experience in the field.

D

Development & Process

The CLEXTRAL 3rd generation

The world of snacks and pellets is evolving: CLEXTRAL is a driving force in this field, and we are pleased to present the most recent developments in this article.

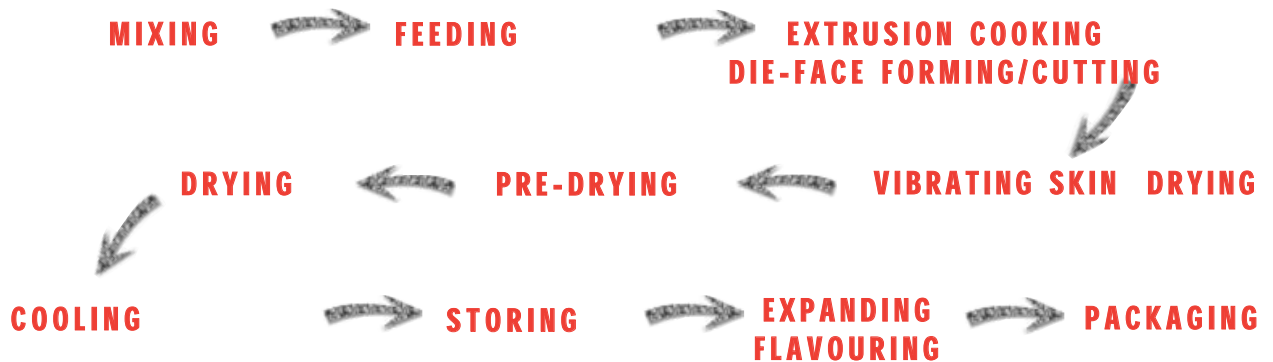

FORMULATION AND INGREDIENTS :

Pellets are made from starch-based raw materials, usually extracted from cereals such as wheat, maize, rice, etc., or tubers such as potatoes, or manioc (tapioca).

The many choices available and the many possibilities created with mixture of these raw materials enables us to produce a wide variety of products.

Depending on the raw materials and the ingredients used, (such as salt, emulsifiers, etc.), the finished snack may be crispy, crackly, hard, soft and crunchy, and so on.

MIXING AND FEEDING :

The mixing time and intensity must be sufficient to ensure a minimum level of mechanical shearing and

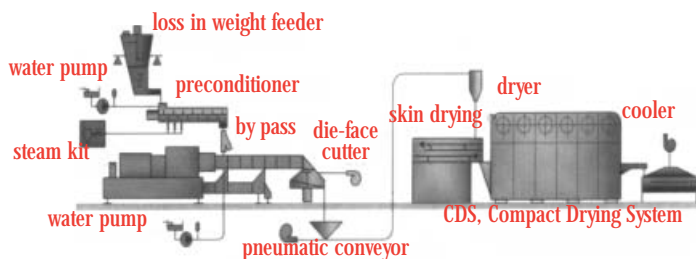

perfect homogeneity of a variety of ingredients.

The mix is then transferred to the extrusion system via a dosing unit that ensures a stable, regular input rate.

PRECONDITIONING :

The main function of the preconditioner is to prepare the mix for the extrusion operation. The addition of water and steam during the continuous mixing enables pre-cooking of the ingredients under the effects of heat and humidity. For a mixture using cereals, the mix at the preconditioner outlet has a moisture level of 18-25% and a temperature of 75-95°.

EXTRUSION :

As compared with the “traditional” process that requires a cooking unit first, followed by a second unit for the cooling/shaping operation, CLEXTRAL has developed a process enabling the cooking and shaping to be carried out in one extrusion operation.

This method provides improved levels of process control, and reduces stopping and restarting times during changeovers for different recipes or product formats. This continuous extrusion operation has two phases: during the initial extrusion phase, the thermomechanical treatment applied to the product results in a starch gelatinization level that gives the end product its characteristics of expansion and crunchiness.

During the second extrusion phase, the product is moved on to the die or “mould” and progressively cooled to a temperature of less than 100°C. The total residence time in the extruder varies from 40 to 60 sec.

process for extrusion of snacks or pellets



Daniel DURAND

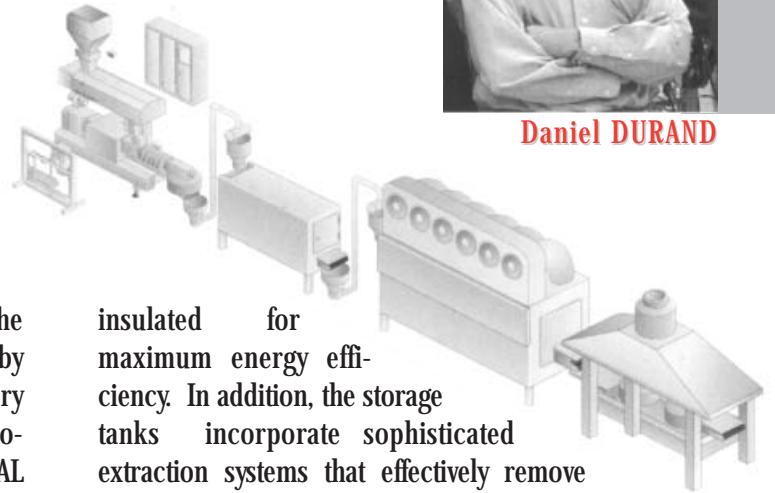

Taking advantage of the experience acquired by CLEXTRAL's subsidiary AFREM in the manufacture of production lines for pasta, the CLEXTRAL Group and AFREM worked together to design cutting equipment for the nozzles and drying units that is specifically suited to the production of

pellets.

The cutting equipment/mould holder unit is fitted with a bypass valve system that enables a very quick mould changeover during production.

Products from a basic recipe using rice, maize or wheat contain 25-30% moisture and maintain a temperature of 80-95 °C once formed into final shape after passing through the mould.

DRYING :

Just as the extrusion process parameters must be strictly regulated, the drying operation must provide conditions that are consistent, precise and reliable.

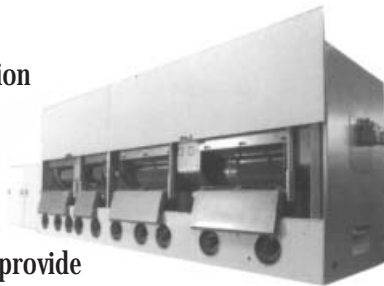

The AFREM-CLEXTRAL dryer is ideally suited for pellet drying, reducing the moisture level in the pellets to 10-12%. This equipment provides a gentle drying process that produces pellets of optimum quality and avoids the problems of cracking and splitting. Moisture levels are consistently controlled during the 3 hour drying period, with dryer temperatures from 70 - 90°C.

STORAGE :

Upon exit from the dryer/cooler, the pellets have a moisture level of 10-12% and are ready for storage prior to packaging or expansion.

The storage tanks have reduced maintenance requirements as they are constructed of stainless steel and fully

insulated for maximum energy efficiency. In addition, the storage tanks incorporate sophisticated extraction systems that effectively remove fine particulate, and are equipped with easy-access inspection covers which provide precise control of temperature, air moisture, and residence times. These features, combined with those of with the rotary drying system, ensure that product integrity and quality are maintained throughout.

EXPANSION - FLAVOURING - PACKAGING :

Prior to their final packaging, the pellets are expanded by frying, hot air or microwave processing.

This final processing reduces the snack moisture level to 3%. Flavours or spices are applied to the expanded

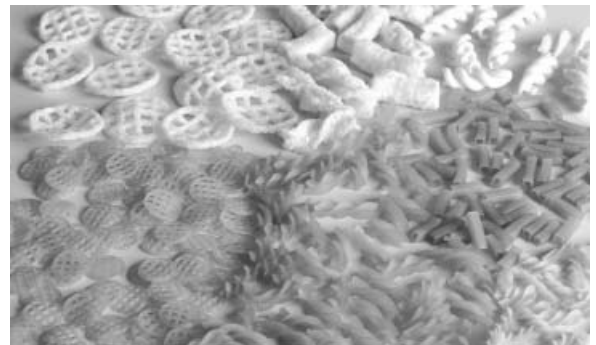

snacks as they pass through a coating tunnel.

Products may be packaged by equipment built by LYMAC-CLEXTRAL, which provides complete packaging systems with the associated weighing machines, baggers, cartoners, glueing machines, and automatic palletizers.

CLEXTRAL GROUP customers are thus able to acquire a complete processing and packaging line, fully integrated for the process, with the guarantee of CLEXTRAL quality, efficiency, and service, thereby ensuring a solid return on their investment.

D

Development & Process

TEXTURIZED
...TO

In recent years, vegetable protein products have been tremendously popular with consumers, and the future looks bright for increased interest in the coming years.

Meat extenders, which are obtained by texturization of dry vegetable proteins (defatted raw materials: flours, concentrates, isolates), are part of

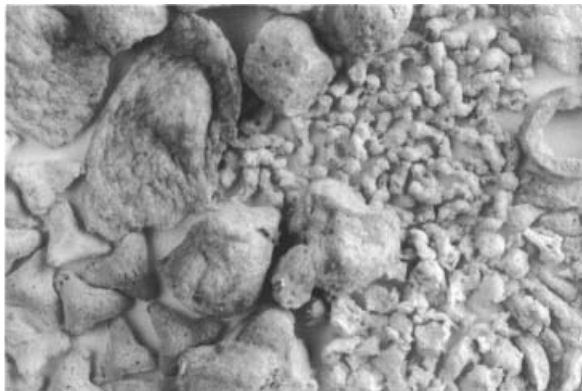

fig1. example of a dry TVP products

this product family.

Extrusion cooking, particularly twin-screw extrusion, is currently the most widespread process utilized in the preparation of the TVP products.

The processing concept is defined by two important steps : first, the thermo-mechanical cooking of proteins in the screw-barrel assembly and next, the protein texturization in the die assembly.

The dry raw materials (protein-based such as soy flour in most cases), liquid additives (such as water), and steam are introduced in the preconditioner, and the mixture is subsequently fed into the extruder. Preconditioning acts to prehumidify and preheat the raw materials and is especially efficient in processing

grits.

As the mixture is conveyed through the extruder barrel by the twin screw assembly, mechanical heat is generated, due to the screw speed and design, and thermal energy is added by the temperature control system, “cooking” the proteins at a low moisture

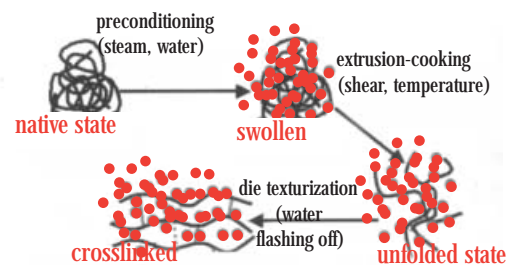

fig2. mechanism of soy protein texturization

content (18 to 27% in the barrel).

This treatment results in the denaturation of proteins, deactivation of antitryptic factors and reduction of bitter flavours.

As processing is completed, the dough enters the die, which concurrently textures and forms the product through cross-linking of protein macromolecules, formation of cell-based structure, and shaping and sizing of the final extrudate.

The texture of the product is obtained by laminar shearing of the protein melt and by moisture flashing off due to the pressure difference as the extrudate exits the die.

A rotating knife cuts the rod of material directly at the die exit. Next, the products enter a dryer to reduce the moisture content down to 8-9%.

This creates a shelf-stable product with excellent micro-biological properties as well as an exceptionally long shelf life.

VEGETABLE PROTEINS : (TVP) MEAT EXTENDERS.



Emmanuel LAVOCAT

Daniel DURAND

The TVP products are evaluated by their functional properties such as bulk density (g/l), water holding capacity (WHC: quantity of liquid water absorbed by TVP product in standardized conditions), texture integrity (TI: objective measurement of the stability of TVP product submitted to temperature treatment and water leaching), external aspect, and shape (visual evaluation of product color, surface aspect, shape, ...).

Variables related to formulation (protein content, protein solubility, oil content, particle size, sugar content, emulsifier, pH, texturization agent, ...) and related to extrusion process (moisture content, screw speed, barrel temperature, ...) influence the TVP extrusion processing and subsequently the final characteristics of the product.

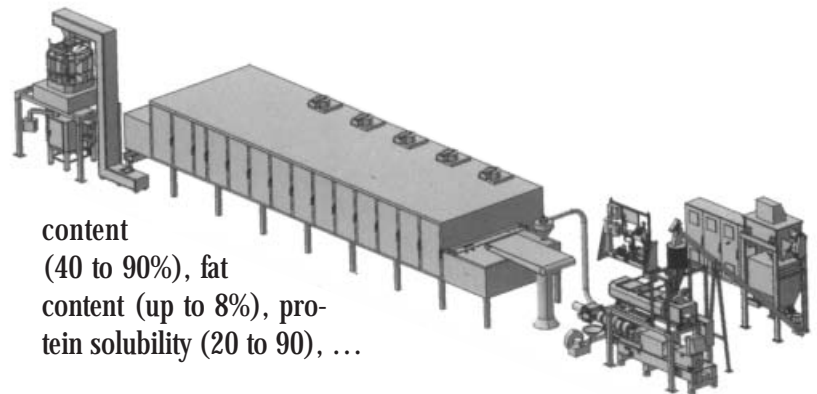

content (40 to 90%), fat content (up to 8%), protein solubility (20 to 90), ...

It provides the opportunity to create a multitude of TVP products in term of texture, shape (such as chunks, granulates, slices, stars, rings) and absorption properties (WHC from 2 to 7). (Fig 4 and 5)

Fig4

Upon re-hydration, TVP products offer a mouthfeel almost identical to meat and have been adopted for

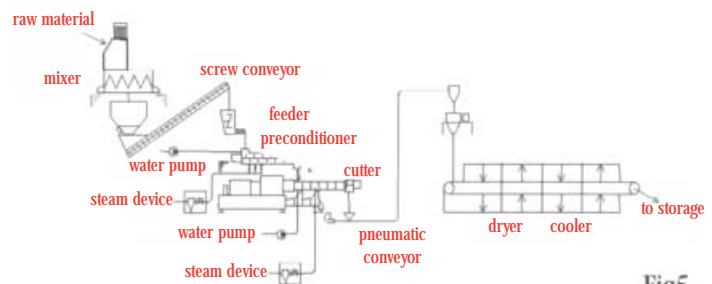

Fig5

vegetarian dishes as a healthy substitute for minced meat.

fig4 and 5. standard TVP production line

TVP products offer good nutritional properties (no cholesterol) and economic advantages (a kilo of TVP is less expensive than a kilo of meat).

TVP chunks also stand up well to boiling and high temperature cooking. They can be used at 25% level or higher in instant or freeze-dried soups, hamburgers, meatloaf, ragouts and special pâtés ...

CLEXTRAL supplies turnkey lines, from design and engineering to installation, commissioning and follow up. Line capacity varies from around 100 kg/h for a small production unit up to 3000 kg/h for major production lines.

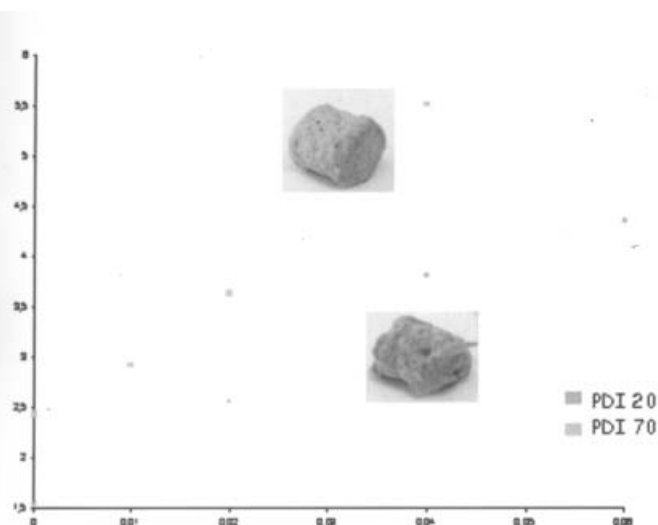

fig3. influence of addition of minor ingredient.

For example, the raw material or the addition of a minor ingredient can greatly affect the final product as shown in figure 3.

Twin-screw extrusion cooking technology enables the processing of diverse raw materials such as protein

E nvironnement

OBTAINING PACKING CEREAL FLOUR

CLEXTRAL has been dedicated to environmental protection for years, providing technologies and processes that help to reduce pollution.

The company's development of technology to produce biodegradable packing products, as an alternative to expanded polystyrene, is a solid example of this dedication. The new biodegradable packing products are designed to replace the expanded polystyrene products that are currently used. Expanded polystyrene is produced from petroleum, a non-renewable source of energy, and the products are not biodegradable. Cereal-based packing products present an alternative that is environmentally friendly in terms of materials, (cereals, a renewable energy source) and pollution reduction (the products are biodegradable). The market for packing products is a major one, estimated at 16 million cubic metres yearly in Europe and the USA.

CLEXTRAL provides complete production lines for cereal-based packing materials and describes the principle in this article.

RAW MATERIALS :

Starch-based products or cereal flour are the main raw materials in biodegradable packing particles created by the high-speed cooking and extrusion process. Starch, a major element of flour, is made up of a mixture of two glucose polymers: amylose and amylopectin. The ratio between these two molecules differs according to their vegetable origin; e.g.:

Native maize	
% of amylose	20-30
% of amylopectin	70-80

The percentage of water to be added in the extruder must be adjusted depending on the moisture level of the flour, which is usually about 12%.

THE MANUFACTURING PROCESS :

This process consists of subjecting the cereal substance to intense thermo-mechanical treatment for a very short period of time, which leads to macromolecular degradation of the starch, giving the resulting product a highly expanded structure.

EVOLUM model extruders with a high rotation speed are utilized. The machine outputs are as follows to obtain a packing product, also known as a technical product:

	EV 53	EV 68	EV 88
Output (cu. m/h) Levels shown for information purposes only	30-50*	70-100*	150-200*

* for a bulk product density of 12 g/l

The product is cut to the desired length using an HC pelletizer fitted with assembled cutters or in a one-piece configuration.



THE PRODUCTS

The physio-chemical properties of extruded packing products depend on a variety of parameters, particularly the formulation and the shape of the particles.

Many shapes may be created. We have selected two shapes as examples: a solid cylinder (3 mm in diameter) and an S shape. The weight of each particle is about 0.22 g.

The following table shows the conditions used to manufacture the product

PRODUCTS FROM EXPANDED BY EXTRUSION-COOKING



Gilles SOUVETON



Machine: EVOLUM 53 HC type cutter, Die with S-shaped inserts				
Screw speed (rpm)	Flour input (kg/h)	Water (kg/h)	Cutters (rpm)	Pressure (bar)
900	450	26	2500	98

It is necessary to determine the characteristics desired for biodegradable expanded packing particles. These include : the apparent density (expressed in g/l), measurements (expressed in mm), resistance to crushing (expressed in N), resilience (expressed in %), residual level of humidity (expressed as a percentage), duration of the thermodynamic balance (expressed in h), biodegradability and composting (standard tests), ecotoxicity of the product (standard test), shock absorption and compression graphs (standard tests), self-locking (standard test), and fire resistance (standard test).

Furthermore, biodegradable packing particles put on the market must comply with current legislation in the countries of distribution. In particular, for Europe, Directive 94/62/CE and the French Decree n° 98-638 concerning the environmental requirements must be taken into account in the design and manufacture of packaging.



The products obtained are characterized by:

- A TRUE IMMOBILIZATION CAPACITY DUE TO EFFICIENT SELF-LOCKING
 - A SIGNIFICANT SHOCK ABSORPTION ABILITY OVER A WIDE RANGE OF LOADS
 - A LOW RATE OF CREEP OVER TIME WHEN UNDER LOAD
- AND THESE QUALITIES ARE OBTAINED AT A RELATIVELY LOW COST THAT IS COMPETITIVE TO THAT OF EXPANDED POLYSTYRENE CHIPS .

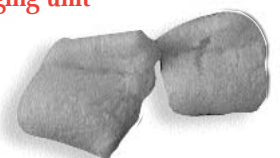
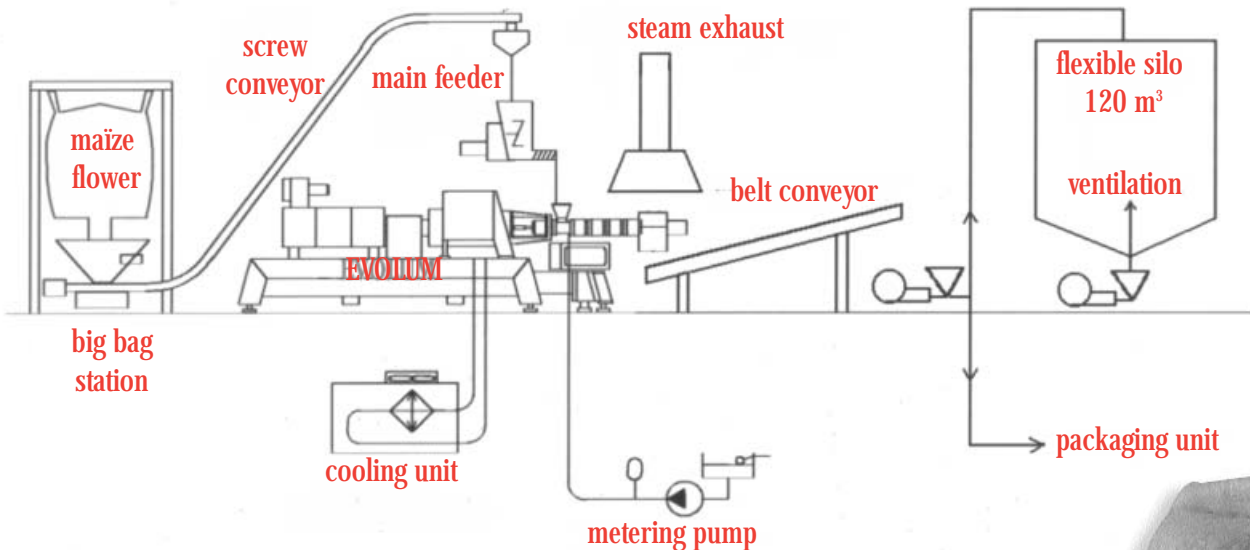

R

Realizations



There is no doubt that the major industrial challenge of the 21st century will be protection of the environment.

Although we can be certain that it will be necessary to make better products at lower cost, the environment will be a major factor in production. Therefore, it is not by chance that in recent years, legislators have focused on producing documents and directives that guide industrial companies to give increasing importance to environmental factors from the design phase forward. Yet, while reducing consumables is a priority, recycling is still an essential tool.

This is evident in European directives currently in preparation, which tend to set requirements for the level of recycling at the end of a product's service life. Eventually all goods will be concerned, but certain products, such as plastics, are already under strong pressure to increase their recycling rates.

In this context, the polyethylene recycling line that our teams started up in October 2000 is exemplary. On one hand, it confirms CLEXTRAL's expertise in supplying lines on a turnkey basis, and on the other hand it shows CLEXTRAL's high level of involvement in terms of protection of the environment.

We associate technological success

with this constant search, as the line enables us to recycle LDP* or HDP* film waste on a continuous basis at a rate of 1,500 kg/h. The reels and waste are fed into a crusher at the beginning of the line and shredded to make confetti about 1 cm square, and of variable thickness (from a few tenths of a micron to 1 mm). Their apparent density is very low (0.1 to 0.2 g/cc).

After thermomechanical treatment in the extruder, filtration, cutting and finally drying, the products obtained are in the form of spherical pellets with an average diameter of about 3 mm. The properties of the products are the same as those of the raw materials except for the viscosity when melted, which tends to diminish. This phenomenon can be explained by the mechanical treatment of the matter inside the machine which reduces the length of the molecular chains, and therefore the molecular mass and the viscosity.

At the end of the line, the pellets are bagged and weighed, and then the bags are loaded on pallets. Other than at the crusher feed, the line requires only one part-time operator, to remove the full pallets and replace the filters (without stopping production); this operation is simplified by an automatic cleaning system that increases the periods between replacements.



& TURNKEY RECYCLING



José Cheio de Oliveira

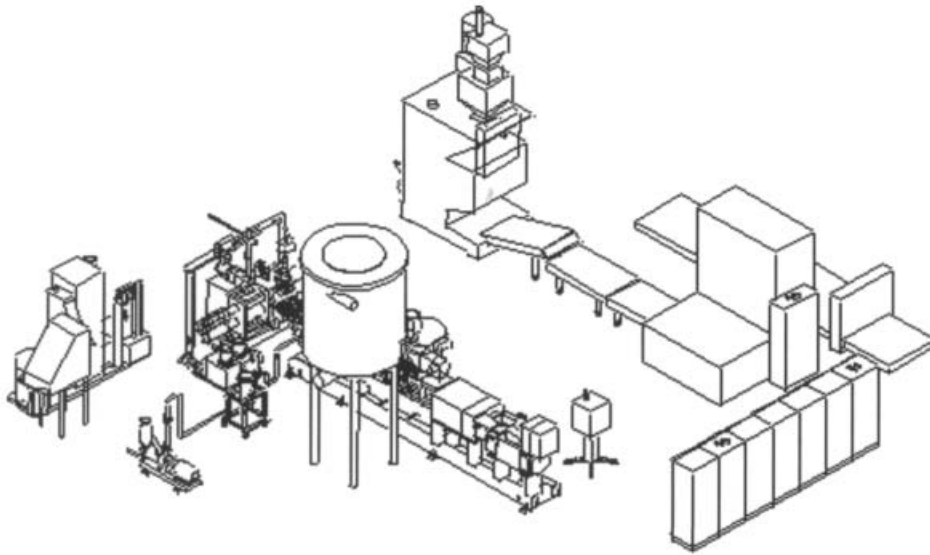

Twin-screw extrusion is justified due to the extruder's ability to manage the severe constraints linked to the products: films that are more and more technical and complex; variable moisture levels of the materials, linked to the waste recovery systems, which often involve outdoor storage (moisture levels of 8 to 10%).

The possibilities of degassing and the flexibility in terms of thermomechanical working areas are the main advantages of the twin-screw technology as compared with other processes already in use.

The line operates at a nominal rate of 1,500 kg/h, 24 hours a day, 5 days a week.

CLEXTRAL can also provide lines with lower capacities, able to recycle on a continuous basis at a rate of about 600 kg/h.

The recycling lines provided by CLEXTRAL are the result of large-scale, careful teamwork; both in the knowledge of the process and in the full control of the project. CLEXTRAL handled the design, manufacture, and installation of the equipment, connection of the fluids, piping, control systems and automatic controllers, commissioning and follow up by the CLEXTRAL Services department.

Our motivation is to conquer the challenge and satisfy our customer.

LDP* : Low density polyethylene
HDP* : High density polyethylene



*The project team (from left to right):
G. Souveton (head of process, plastic dpt);
Y. Sanial (sales / engineering);
J. Cheio de Oliveira (project manager);
Ph. Penel (sales eng, plastic dpt)
C. Bruyère (mechanical engineering);
T. Jarousse (head of automation);
S. Colomb (electrical engineering);*

*Absent: C. Bugnazet (electrical engineering);
R. Brouillat (site foreman)*

Questionnaire :

To help us better meet your requirements, please let us know how you would like to receive the new CLEXTRAL newsletter.

1- Would you like to receive future issues in printed form?

yes no

2- Would you prefer to receive an email when the newsletter is published at www.clextrusion.com?

yes no

3- Please fill in the data boxes below and return the form, preferably before 27 February 2004, either by letter to the attention of:

Mariel Badel, CLEXTRAL, 1 rue du Colonel Riez, 42700 Firminy, FRANCE

By email to : mbadel@clextral.com, by fax to : +33 4 77 40 31 23

Company:
First name :
Last name :
Postal address :
Street :
Town:
Postcode :
Country :
Email address :

Please feel free to copy this page if you would like to arrange for another person to receive our newsletter.

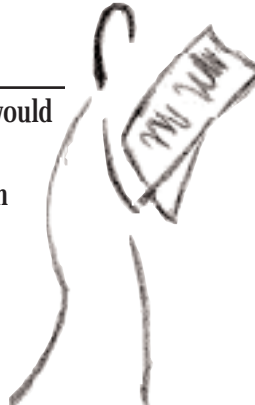

In accordance to the french law No 17 dated January 6th 1978, you have the right of access, modification or cancellation of your non-trade data administered by us - CLEXTRAL - 1 rue du Colonel RIEZ - 42700 FIRMINY FRANCE.

CLEXTRAL S.A.S.

B.P 10

42702 Firminy cedex

FRANCE

Tel. +33 (0) 4 77 40 31 31

Fax. +33 (0) 4 77 40 31 23

E.mail : clxsales@clextral.com

CLEXTRAL Inc.

14450 Carlson Circle

Tampa, FL 33626 USA

Tel. +1 813 8544434

Fax. +1 813 8552269

E.mail : clextralusa@clextralusa.com

CLEXTRAL Asia Pacific

4th floor, 74 C Duxton road

SINGAPORE 089533

Tel. +65 6 225 27 26

Fax. +65 6 225 29 39

E.mail : eallibe@clextral.com

CLEXTRAL Latin America

C/O CFCCI

Marchant Pereira 201, OF.701

PROVIDENCIA

SANTIAGO

CHILE

Tel. +56 2 225 55 47

Fax. +56 2 225 55 45

E.mail : llacau@clextralusa.com

jcoelho@clextralusa.com

CLEXTRAL China

Room 9001

Novel Building

887 Huai Road (M)

SHANGHAI 200020

CHINA

Tel. +86 21 64747806

Fax. +86 21 64746808

E.mail : jchen@uninet.com.cn

Exhibitions...

You can meet the CLEXTRAL Group teams during a number of shows :

SNAXPO	Philadelphia, USA, 21-23 March 2004
FOOD TECH	Istanbul, TURKEY, 25-28 March 2004
FRANCE EXPO	Casablanca, MOROCCO, 10-13 March 2004
PET FOOD FORUM	Chicago, USA, March 2004
AquaSur	Puerto Montt, CHILE, 19-22 March 2004-stand E9
PACKTECH FOODTECH	Shanghai, CHINA, 30/03-1/04 2004
DJAZAGRO	Algiers, ALGERIA, 5-8 April 2004
MEB	Cairo, EGYPT, 10-13 May 2004
VICTAM	Utrecht, NETHERLANDS, 11-13 May 2004
IRAN AGRO FOOD	Tehran, IRAN, 23-26 May 2004
FISPAL	Sao Paulo, BRAZIL, June 2004

In brief...

CLEXTRAL receive the IMPLANTIS award

During the recent opening ceremony of the "CLASSE EXPORT" exhibition held in Lyon on the 26th November 2003, Mr. George Jobard, President of the CLEXTRAL Group, was presented with the "IMPLANTIS" trophy by Mr. François Loos, Deputy Foreign Trade Minister. The trophy has been awarded in recognition of the long term commercial activities of the group in all 5 continents, an achievement which is supported by the installation of four offices in Tampa USA, Santiago, Singapore and Shanghai.

The presentation of the trophy was sponsored by Mrs. Lévy, Vice President of the Rhône- Alpes Region , and Mrs. Perotti-Reille, President of ERAI, (Entreprise Rhône-Alpes International).

The CLEXTRAL Group, which has its headquarters in Firminy, Loire, was created in 2002, with the merger of CLEXTRAL with AFREM and LYMAC, two Lyon based companies, who also specialize in the supply of equipment, particularly destined for the food industry.

CLEXTRAL has obtained renewal of its BVQI quality certification

The renewal was carried out in accordance with ISO 9001, 2000 version, under the N° 113 640 A and B, dated 9 October 2003.

